

MARK	N A M E
Ar	MAIN GENERATOR ARMATURE WINDING
Fg	MAIN GENERATOR FIELD WINDING
ExAr	EXCITER ARMATURE WINDING
ExFg	EXCITER FIELD WINDING
AVR	AUTOMATIC VOLTAGE REGULATOR
VR	VOLTAGE REGULATING RHEOSTAT
Re	RECTIFIER
CT1~3	CURRENT TRANSFORMER 300/5A
CB1	CIRCUIT BREAKER 500A
OC	OVER CURRENT RELAY
OC.T.B	VOLTAGE CHANGE-OVER BOARD
AS	AMMETER CHANGE-OVER SWITCH
A	AC.AMMETER 0-300,600A
VS	VOLTMETER CHANGE-OVER SWITCH
V	AC.VOLTMETER 0-600V
F	FREQUENCY METER 45-65Hz
PL1	PILOT LAMP
CB2,3	AUX.CIRCUIT BREAKER 20A
CB4~6	AUX.CIRCUIT BREAKER 50A
CON1,2	AUX.POWER RECEPTACLE 20A
CON3~5	AUX.POWER RECEPTACLE 50A
Re1	RECTIFIER
IL	PANEL LIGHT
SW1	PANEL LIGHT SWITCH

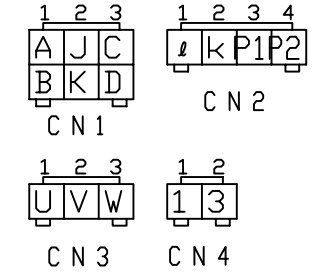

AVR CONNECTOR  
(View from inserting wire side)

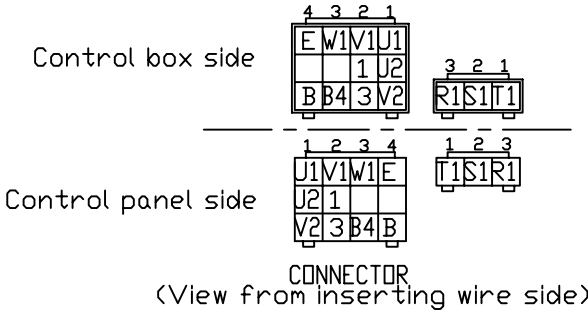

CONNECTOR  
(View from inserting wire side)

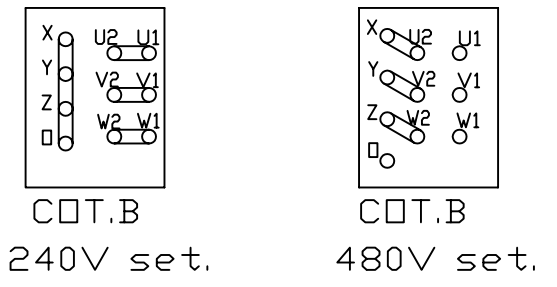

NO MARK:1.25mm<sup>2</sup>

WIRE SIZE	COLOR CODE
100: 100mm <sup>2</sup>	WIRE COLOR
50: 50mm <sup>2</sup>	B BRACK R RED
38: 38mm <sup>2</sup>	L BLUE W WHITE
22: 22mm <sup>2</sup>	BR BROWN Y YELLOW
14: 14mm <sup>2</sup>	G GREEN LB LIGHT BLUE
8: 8mm <sup>2</sup>	GR GRAY LG LIGHT GREEN
5.5: 5.5mm <sup>2</sup>	V VIOLET O ORANGE
2: 2mm <sup>2</sup>	P PINK



DCA-180SSK(MQ)

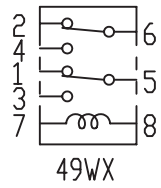

RELAY INSIDE CONNECTION

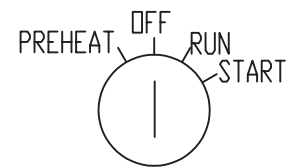
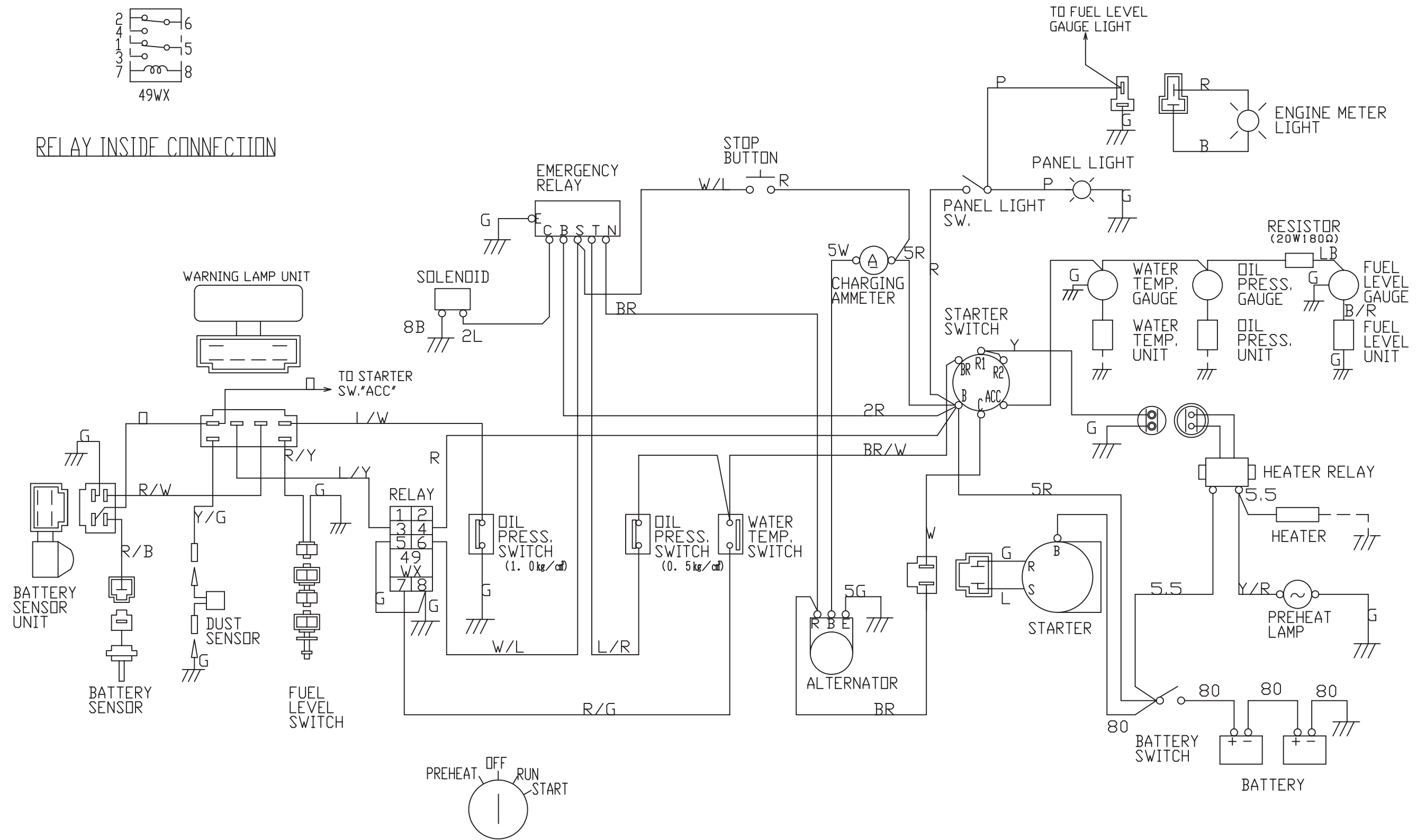

STARTER SWITCH

WIRE SIZE	COLOR CODE
80 : 80mm <sup>2</sup>	MARK WIRE COLOR MARK WIRE COLOR
5.5 : 5.5mm <sup>2</sup>	B BLACK R RED
5 : 5mm <sup>2</sup>	L BLUE W WHITE
2 : 2mm <sup>2</sup>	BR BROWN Y YELLOW
	G GREEN LB LIGHT BLUE
	GR GRAY LG LIGHT GREEN
NO MARK WIRE SIZE : 1.25mm <sup>2</sup>	V VIOLET O ORANGE
	P PINK

	STARTER SW. CONNECTION					
	B	BR	R1	R2	C	ACC
OFF	○					
PREHEAT	○	○	○			○
RUN	○	○				○
START	○	○		○	○	○

DCA180SSK WITH KEY ENGINE WIRING DIAGRAM

# DCA-180SSK — ENGINE WIRING DIAGRAM

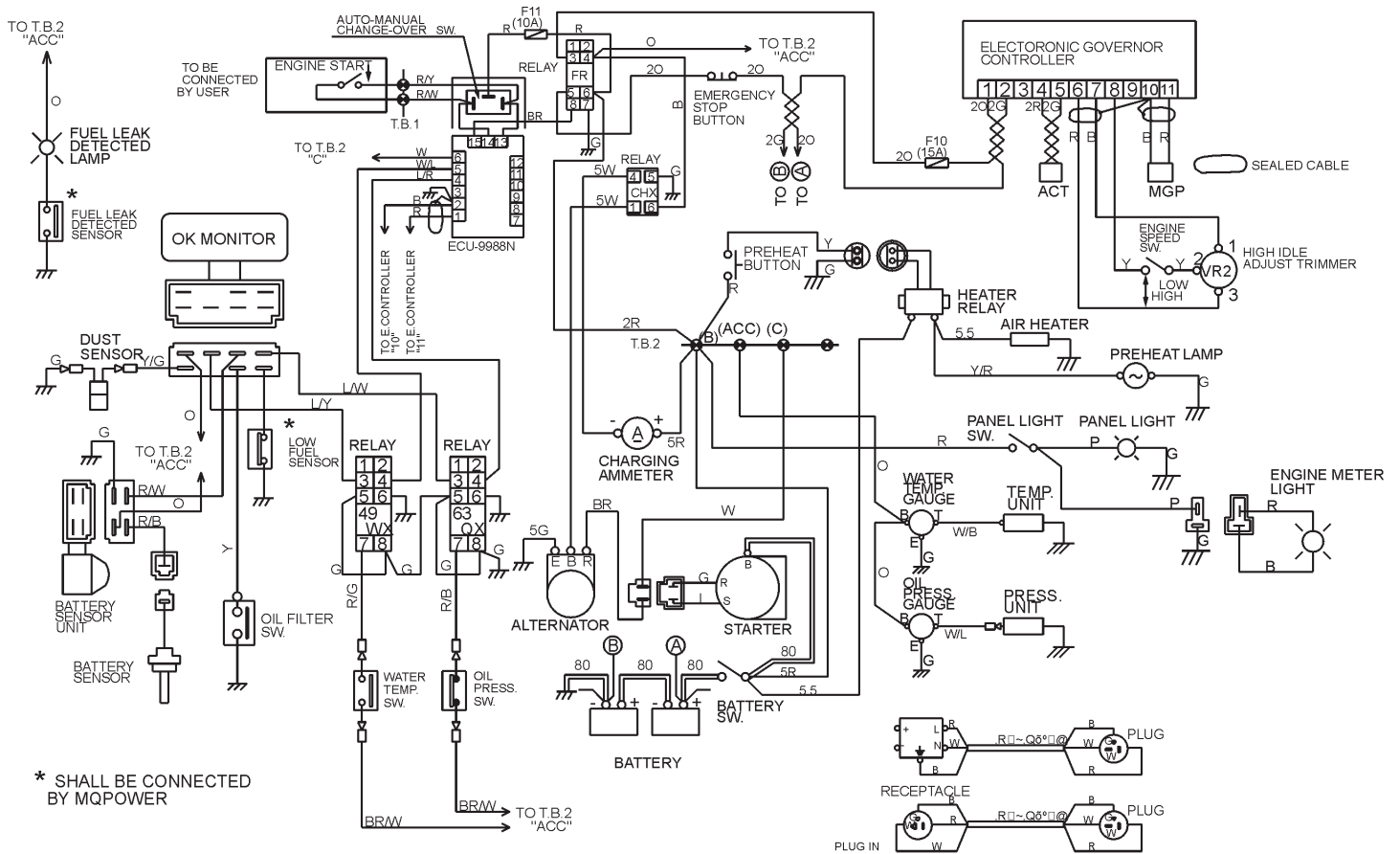

\* SHALL BE CONNECTED BY MQPOWER

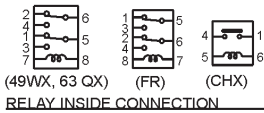

WIRE SIZE	COLOR CODE	
	WIRE COLOR	WIRE COLOR
100: 100mm <sup>2</sup>		
38: 38mm <sup>2</sup>	B BLACK	R RED
22: 22mm <sup>2</sup>	L BLUE	W WHITE
14: 14mm <sup>2</sup>	BR BROWN	Y YELLOW
5: 5mm <sup>2</sup>	G GREEN	LB LIGHT BLUE
2: 2mm <sup>2</sup>	GR GRAY	LG LIGHT GREEN
NO MARK WIRE SIZE	V VIOLET	O ORANGE
	P PINK	

WITH ECU AND EGS